



---

**EDN PRÉ-FABRICADOS**

# **CATÁLOGO DE PRODUTOS**

Fevereiro - 2022

# Índice

- 03 - Anéis
- 04 - Tampa Anel | Caixas de Passagem
- 05 - Blocos | Meios Blocos | Calhas
- 06 - Cobogó
- 07 - Cobogó
- 08 - Cobogó
- 09 - Cobogó
- 10 - Cobogó
- 11 - Cochos | Tinas
- 12 - Cumeeira | Rufo | Chapim | Banco Jardim
- 13 - Estacas | Mourões
- 14 - Trilho | Tijolo Laje | Fôrro Completo
- 15 - Pias | Lavanderias
- 16 - Manilhas
- 17 - Meio Fios | Gelo Baiano
- 18 - Revestimentos
- 19 - Revestimentos
- 20 - Revestimentos | Pezão Jardim
- 21 - Pedras Diversas
- 22 - Piso Intertravado
- 23 - Piso Intertravado | Piso Tátil
- 24 - Piso Grama | Grade Cerca
- 25 - Tampa com Moldura | Meia Cana
- 26 - Ralos
- 27 - Cruzetas | Postes
- 28 - Postes | Churrasqueiras
- 29 - Vergas | Vigas | Ferragens em Geral
- 30 - Jarros
- 31 - Comportas
- 32 - Cabeças de Comporta | “L”
- 33 - Manilha em U | Retro | Munck
- 34 - Caçamba | Betoneira | Equipamentos Elétricos
- 35 - Piscinas
- 36 - Piscinas
- 37 - Piscinas
- 38 - Piscinas
- 39 - Piscinas



**ANEL EM CONCRETO**

<b>ACN001</b>	D = 1,00M / H = 0,5M / P = 4CM / C = 0,39M <sup>3</sup>
<b>ACN012</b>	D = 1,20M / H = 0,5M / P = 4CM / C = 0,56M <sup>3</sup>
<b>ACN015</b>	D = 1,50M / H = 0,5M / P = 5CM / C = 0,88M <sup>3</sup>
<b>ACN020</b>	D = 2,00M / H = 0,5M / P = 8CM / C = 1,57M <sup>3</sup>

**ANEL EM CONCRETO DRENANTE**

<b>ACD001</b>	D = 1,00M / H = 0,5M / P = 4CM / C = 0,39M <sup>3</sup>
<b>ACD012</b>	D = 1,20M / H = 0,5M / P = 4CM / C = 0,56M <sup>3</sup>
<b>ACD015</b>	D = 1,50M / H = 0,5M / P = 5CM / C = 0,88M <sup>3</sup>
<b>ACD020</b>	D = 2,00M / H = 0,5M / P = 8CM / C = 1,57M <sup>3</sup>



**ANEL EM CONCRETO COM FUNDO**

<b>ACF001</b>	D = 1,00M / H = 0,5M / P = 4CM / C = 0,39M <sup>3</sup>
<b>ACF012</b>	D = 1,20M / H = 0,5M / P = 4CM / C = 0,56M <sup>3</sup>
<b>ACF012</b>	D = 1,50M / H = 0,5M / P = 5CM / C = 0,88M <sup>3</sup>
<b>ACF020</b>	D = 2,00M / H = 0,5M / P = 8CM / C = 1,57M <sup>3</sup>

**D = DIÂMETRO / H = ALTURA / P = PAREDE / C = CAPACIDADE**



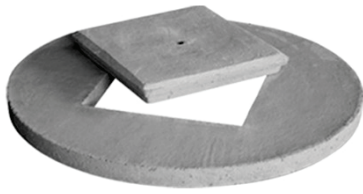

**TAMPA COM SOBRETAMPA**

- TST001** TAMPA SOBRETAMPA 30x30 / D = 1,00M / H = 4CM
- TST012** TAMPA SOBRETAMPA 30x30 / D = 1,20M / H = 4CM
- TST015** TAMPA SOBRETAMPA 60x60 / D = 1,50M / H = 4CM
- TST020** TAMPA SOBRETAMPA 60x60 / D = 2,00M / H = 4CM

COD: TAC

**TAMPA EM CONCRETO PARA ANEL**

- TAC001** TAMPA CONCRETO P/ ANEL D = 1,00M / H = 4CM
- TAC012** TAMPA CONCRETO P/ ANEL D = 1,20M / H = 4CM
- TAC015** TAMPA CONCRETO P/ ANEL D = 1,50M / H = 5CM
- TAC020** TAMPA CONCRETO P/ ANEL D = 2,00M / H = 6CM



COD: CPT



**CAIXA DE PASSAGEM**

- CPT001** CAIXA DE PASSAGEM EM CONCRETO COM TAMPA 37 x 40 x 47CM
- CPT002** CAIXA DE PASSAGEM EM CONCRETO COM TAMPA - SOB ENCOMENDA





**BLOCO VEDAÇÃO**

**BLV009** BLOCO VEDAÇÃO EM CONCRETO 09 x 19 x 39CM

**BLV014** BLOCO VEDAÇÃO EM CONCRETO 14 x 19 x 39CM

**MEIO BLOCO EM CONCRETO**

**MBL009** MEIO BLOCO EM CONCRETO 09 x 19 x 19CM

**MBL014** MEIO BLOCO EM CONCRETO 14 x 19 x 19CM

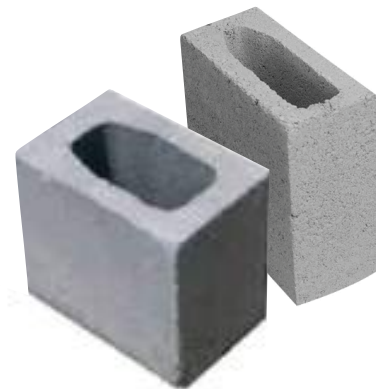

**CALHA EM CONCRETO**

**CAL009** CALHA EM CONCRETO 09 x 19 x 39CM

**CAL014** CALHA EM CONCRETO 14 x 19 x 39CM



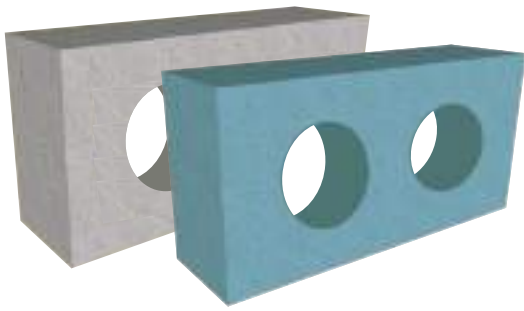

**COBOGÓ 2 FUROS**

**CBG001** COBOGÓ 2 FUROS SL 15 x 30CM / H8 / 22 P/M<sup>2</sup>

**CBG101** COBOGÓ 2 FUROS SL 15 x 30CM / H8 / 22 P/M<sup>2</sup>  
PIGMENTADO

**COBOGÓ 4 FUROS**

**CBG002** COBOGÓ 4 FUROS SL 24 x 24CM / 17 P/M<sup>2</sup>

**CBG102** COBOGÓ 4 FUROS SL 24 x 24CM / 17 P/M<sup>2</sup>  
PIGMENTADO

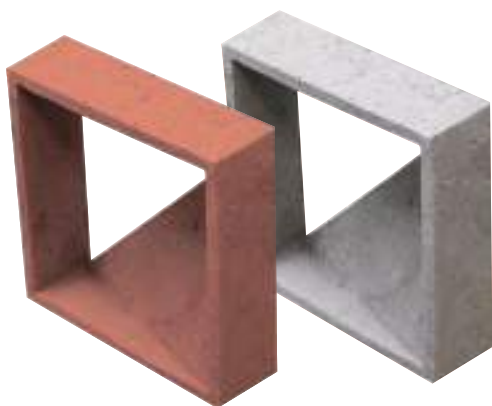
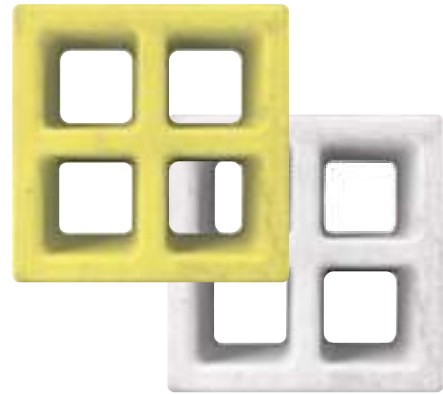

**COBOGÓ PIRÂMIDE**

**CBG003** COBOGÓ PIRÂMIDE 30 x 30 x 07 CM / 11 P/M<sup>2</sup>

**CBG103** COBOGÓ PIRÂMIDE 30 x 30 x 07 CM / 11 P/M<sup>2</sup>  
PIGMENTADO



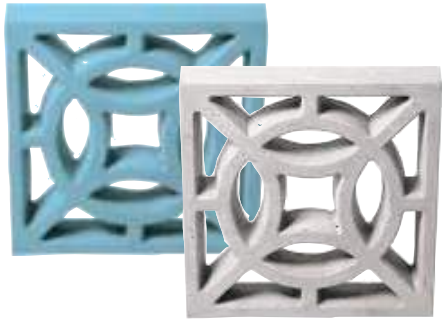

**COBOGÓ 4 PONTAS**

**CBG004** COBOGÓ 4 PONTAS SL 40 x 40 x 07CM / 6,2 P/M<sup>2</sup>

**CBG104** COBOGÓ 4 PONTAS SL 40 x 40 x 07CM / 6,2 P/M<sup>2</sup> PIGMENTADO

**COBOGÓ 16 FUROS**

**CBG005** COBOGÓ 16 FUROS RETO 40x40x07CM / 6,2 P/M<sup>2</sup>

**CBG105** COBOGÓ 16 FUROS RETO 40x40x07CM / 6,2 P/M<sup>2</sup> PIGMENTADO

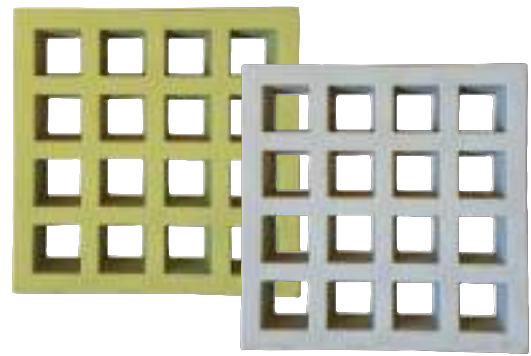

**COBOGÓ 16 FUROS ANTICHUVA**

**CBG006** COBOGÓ 16 FUROS ANTICHUVA SL 40x40x 07CM / 6,2 P/M<sup>2</sup>

**CBG106** COBOGÓ 16 FUROS ANTICHUVA SL 40x40x 07CM / 6,2 P/M<sup>2</sup> PIGMENTADO

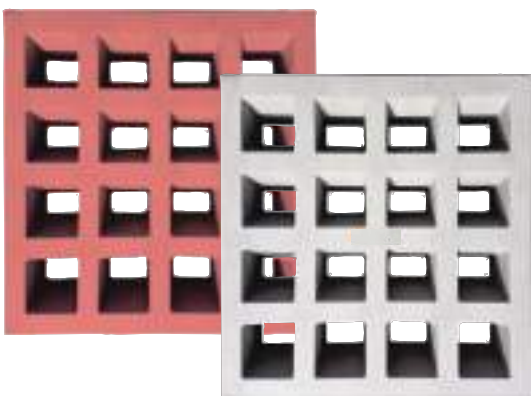

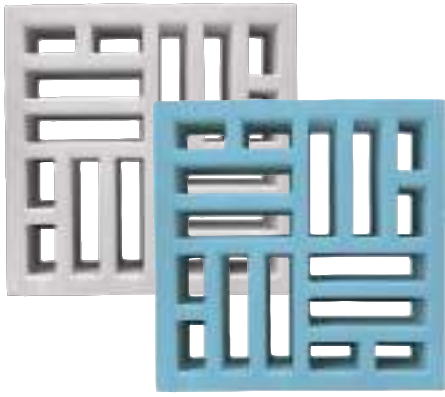

### COBOGÓ TACO CHINÊS

**CBG007** COBOGÓ TACO CHINÊS 40 x 40 x 07CM / 6,2 P/M<sup>2</sup>

**CBG107** COBOGÓ TACO CHINÊS 40 x 40 x 07CM / 6,2 P/M<sup>2</sup>  
PIGMENTADO

### COBOGÓ ÁRABE

**CBG008** COBOGÓ ÁRABE SL 40 x 40 x 07CM / 6,2 P/M<sup>2</sup>

**CBG108** COBOGÓ ÁRABE SL 40 x 40 x 07CM / 6,2 P/M<sup>2</sup>  
PIGMENTADO

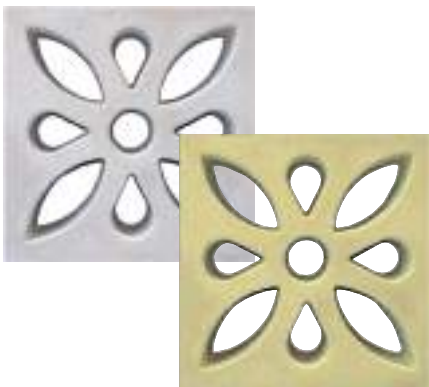
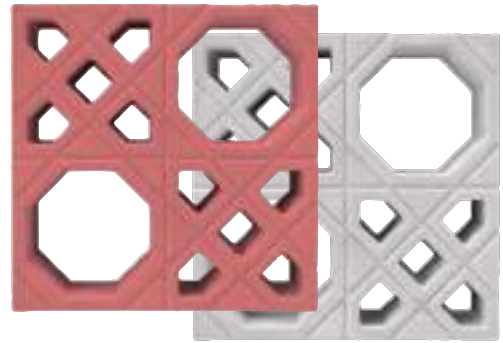

### COBOGÓ FLOR

**CBG009** COBOGÓ FLOR SL 40 x 40 x 07CM / 6,2 P/M<sup>2</sup>

**CBG109** COBOGÓ FLOR SL 40 x 40 x 07CM / 6,2 P/M<sup>2</sup>  
PIGMENTADO





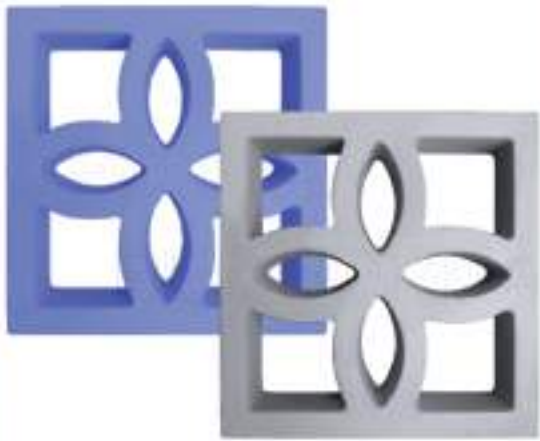

**COBOGÓ PÉTALAS**

**CBG010** COBOGÓ PÉTALAS 30 X 30 X 7 CM / 11 P/M<sup>2</sup>

**CBG110** COBOGÓ PÉTALAS 30 X 30 X 7 CM / 11 P/M<sup>2</sup>  
PIGMENTADO

**COBOGÓ MARGARIDA**

**CBG011** COBOGÓ MARGARIDA 30 X 30 X 7 CM / 11 P/M<sup>2</sup>

**CBG111** COBOGÓ MARGARIDA 30 X 30 X 7 CM / 11 P/M<sup>2</sup>  
PIGMENTADO



**COBOGÓ QUADRADOS SOBREPOSTOS**

**CBG012** COBOGÓ QUADRADOS SOBREPOSTOS  
30 X 30 X 10 CM / 11 P/M<sup>2</sup>

**CBG112** COBOGÓ QUADRADOS SOBREPOSTOS  
30 X 30 X 10 CM / 11 P/M<sup>2</sup> - PIGMENTADO



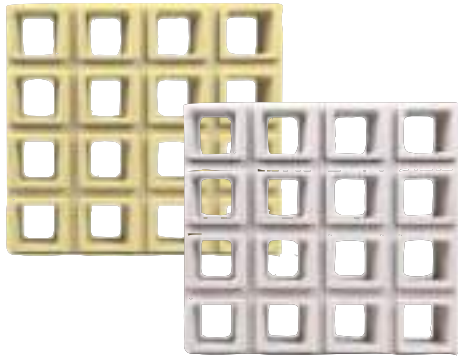

**COBOGÓ COMPOSÊ 16 FUROS**

**CBG013**

COBOGÓ COMPOSÊ 16 FUROS  
SL / 42 x 44 x 07CM / 5,7 P/M<sup>2</sup>

**CBG113**

COBOGÓ COMPOSÊ 16 FUROS  
SL / 42 x 44 x 07CM / 5,7 P/M<sup>2</sup> PIGMENTADO

**COBOGÓ BIZOLÉ**

**CBG014**

COBOGÓ BIZOLÉ ANTICHUVA 11 X 12 X 33 CM



**CBC001**



**CBC002**



**CBC003**



**CBC004**

**COBOGÓ CERÂMICO**

**CBC001**

COBOGÓ CERÂMICO ESTRELA I | 10 x 18 x 18 CM  
2,4KG / 24 P/M<sup>2</sup>

**CBC002**

COBOGÓ CERÂMICO ESTRELA II | 10 x 18 x 18 CM  
2,4KG / 23 P/M<sup>2</sup>

**CBC003**

COBOGÓ CERÂMICO ESTRELA III | 10 x 19 x 19 CM  
2,4KG / 23 P/M<sup>2</sup>

**CBC004**

COBOGÓ CERÂMICO SOL | 10 x 18 x 18 CM  
2,4KG / 24 P/M<sup>2</sup>





COCHO ANIMAL

**CHO001** COCHO BOVINO BASE TRIPLA 300X60X50CM

COCHO ANIMAL

**CHO002** COCHO OVINO BASE DUPLA 140X30X30CM

**CHO003** COCHO SUÍNO REBAIXADO 140X30X20CM

**CHO004** COCHO SUÍNO REBAIXADO 100X30X20CM



COCHO TINA

**CHT001** COCHO TINA GRANDE H=35 D=70CM

**CHT002** COCHO TINA PEQUENO H=30 D=67CM





CUMEEIRA / RUFO EM CONCRETO

**CUM001** CUMEEIRA CONCRETO 80 x 50 x 13CM  
P/TELHADO EM PALHA

**RUF001** RUFO (MEDIDA POR ENCOMENDA)

CHAPIM MURO

**CMD001** CHAPIM MURO DOBRADO 100 x 24 x 5CM

**CMS001** CHAPIM MURO SIMPLES 100 x 17 x 5CM



MINI BANCO JARDIM

**BMJ001** BANCO MINI EM CONCRETO PARA JARDIM  
C = 1 M / H = 0,4M

**C = COMPRIMENTO / H = ALTURA**





**TRILHO LINEAR PARA FÔRRO**

**TRI001**

TRILHO LINEAR CONCRETO PARA FÔRRO  
H = 3CM / L = 12CM

COD: LAJ

**TIJOLO CERÂMICO LAJE**

**LAJ001**

TIJOLO CERÂMICO LAJE H = 8CM / 33 x 19CM



COD: FOR

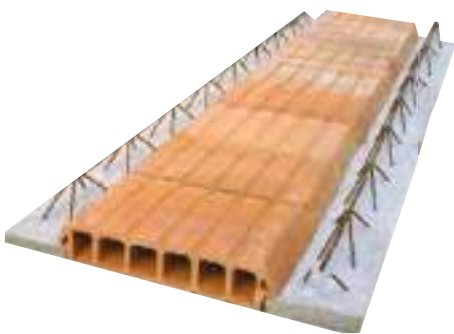

**FÔRRO COMPLETO**

**FOR001**

FÔRRO COMPLETO M<sup>2</sup>





### ESTACA RETA EM CONCRETO

- EST001** ESTACA CONCRETO RETA 220 x 10 x 10CM
- EST002** ESTACA CONCRETO RETA 240 x 10 x 10CM
- EST003** ESTACA CONCRETO RETA 220 x 12 x 12CM

### ESTACA CURVADA EM CONCRETO

- EST004** ESTACA CONCRETO CURVADA 240 x 10 x 10CM
- EST005** ESTACA CONCRETO CURVADA 260 x 10 x 10CM
- EST006** ESTACA CONCRETO CURVADA 290 x 10 x 10CM
- EST007** ESTACA CONCRETO CURVADA 'T' 240 x 10 x 10CM



### MOURÃO ESTICADOR RETO

- MOU001** MOURÃO ESTICADOR RETO 220 x 15 x 15CM
- MOU002** MOURÃO ESTICADOR RETO 230 x 15 x 15CM





**PIA PRIME PARA COZINHA**

**PIA001** PIA PRIME 1,10M CLARA

**PIA002** PIA PRIME 1,10M ESCURA

COD: LAV

**LAVANDERIA PRIME 2 CUBAS**

**LAV001** LAVANDERIA PRIME 2 CUBAS 1,30M CLARA

**LAV002** LAVANDERIA PRIME 2 CUBAS 1,30M ESCURA



COD: LAV

**LAVANDERIA PRIME 3 CUBAS**



**LAV003** LAVANDERIA PRIME 3 CUBAS 1,50M CLARA

**LAV004** LAVANDERIA PRIME 3 CUBAS 1,50M ESCURA





**MANILHA EM CONCRETO ARMADO M/F**

<b>MMF015</b>	MANILHA CONCRETO D = 15CM / H = 50CM M/F
<b>MMF020</b>	MANILHA CONCRETO D = 20CM / H = 50CM M/F
<b>MMF030</b>	MANILHA CONCRETO D = 30CM / H = 50CM M/F
<b>MMF040</b>	MANILHA CONCRETO D = 40CM / H = 50CM M/F
<b>MMF060</b>	MANILHA CONCRETO D = 60CM / H = 100CM M/F
<b>MMF080</b>	MANILHA CONCRETO D = 80CM / H = 100CM M/F
<b>MMF100</b>	MANILHA CONCRETO D = 100CM / H = 100CM M/F
<b>MMF120</b>	MANILHA CONCRETO D = 120CM / H = 100CM M/F

**COD: MPB**

**MANILHA EM CONCRETO ARMADO P/B**

<b>MPB020</b>	MANILHA CONCRETO D = 20CM / H = 100CM / P = 2CM P/B
<b>MPB030</b>	MANILHA CONCRETO D = 30CM / H = 100CM / P = 4CM P/B
<b>MPB040</b>	MANILHA CONCRETO D = 40CM / H = 100CM / P = 6CM P/B
<b>MPB060</b>	MANILHA CONCRETO D = 60CM / H = 100CM / P = 7CM P/B
<b>MPB080</b>	MANILHA CONCRETO D = 80CM / H = 100CM / P = 10CM P/B
<b>MPB100</b>	MANILHA CONCRETO D = 100CM / H = 100CM / P = 12CM P/B
<b>MPB120</b>	MANILHA CONCRETO D = 120CM / H = 100CM



**COD: MAP**

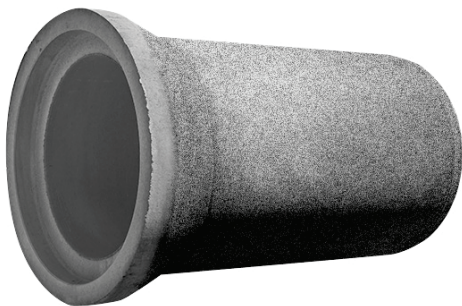

**MANILHA EM CONCRETO POROSO**

<b>MAP020</b>	MANILHA DRENANTE D = 20CM / H = 100CM / P = 2CM
<b>MAP030</b>	MANILHA DRENANTE D = 30CM / H = 100CM / P = 4CM
<b>MAP040</b>	MANILHA DRENANTE D = 40CM / H = 100CM / P = 6CM
<b>MAP060</b>	MANILHA DRENANTE D = 60CM / H = 100CM / P = 7CM
<b>MAP080</b>	MANILHA DRENANTE D = 80CM / H = 100CM / P = 10CM
<b>MAP100</b>	MANILHA DRENANTE D = 100CM / H = 100CM / P = 12CM
<b>MAP120</b>	MANILHA DRENANTE D = 120CM / H = 100CM

**D = DIÂMETRO / H = ALTURA / P = PAREDE**







MEIO FIO

- MFI001** MEIO FIO 100 x 30 x 10 x 08CM
- MFI002** MEIO FIO 100 x 35 x 12 x 10CM
- MFI003** MEIO FIO 100 x 35 x 16 x 15CM
- MFI004** MEIO FIO 100 x 25 x 15 x 10CM

MEIO FIO SUPER LISO | JARDIM

- MFI005** MEIO FIO SUPER LISO 80 x 30 x 10 x 10CM
- MFI006** MEIO FIO JARDIM SUPER LISO 80 x 25 x 4CM
- MFI007** MEIO FIO JARDIM LISO ONDAS 80 x 20 x 5CM



GELO BAIANO

- GBC001** GELO BAIANO 100 x 30 x 22 x 10 x 20CM
- GBC002** MINI GELO BAIANO 30 x 30 x 22 x 10 x 20CM





REVESTIMENTO I

**REV001** REVESTIMENTO PAREDE DE ENCAIXE  
35CM X 28CM / 10 P/ M<sup>2</sup>

**REV101** REVESTIMENTO PAREDE DE ENCAIXE  
35CM X 28CM / 10 P/ M<sup>2</sup> PIGMENTADO

COD: REV

REVESTIMENTO II

**REV002** REVESTIMENTO PAREDE DE ENCAIXE  
29CM X 29CM / 12 P/ M<sup>2</sup>

**REV102** REVESTIMENTO PAREDE DE ENCAIXE  
29CM X 29CM / 12 P/ M<sup>2</sup> PIGMENTADO



COD: REV

REVESTIMENTO III

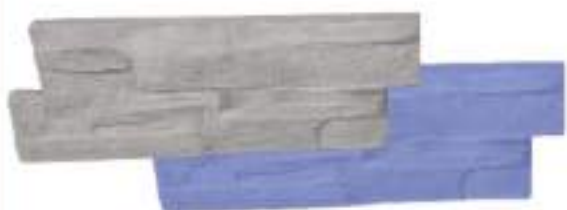

**REV003** REVESTIMENTO TIPO PEDRA LASCADA 1  
49 x 19 x 2 CM / 11 P/M<sup>2</sup>

**REV103** REVESTIMENTO TIPO PEDRA LASCADA 1  
49 x 19 x 2 CM / 11 P/M<sup>2</sup> - PIGMENTADO



REVESTIMENTO IV



REV004

REVESTIMENTO TIPO PEDRA LASCADA 2  
49 x 19 x 2 CM / 11 P/M<sup>2</sup>

REV104

REVESTIMENTO TIPO PEDRA LASCADA 2  
49 x 19 x 2 CM / 11 P/M<sup>2</sup> - PIGMENTADO

COD: REV

REVESTIMENTO V

REV005

REVESTIMENTO LADRILHO QUADRADO TIJOLINHO  
MADEIRA 30 x 30 x 3 CM / 11 P/ M<sup>2</sup>

REV105

REVESTIMENTO LADRILHO QUADRADO TIJOLINHO  
MADEIRA 30 x 30 x 3 CM / 11 P/ M<sup>2</sup> - PIGMENTADO



COD: REV

REVESTIMENTO VI



REV006

REVESTIMENTO PAREDE/PISO TIJOLINHOS  
50 x 50CM / 4 P/M<sup>2</sup>

REV106

REVESTIMENTO PAREDE/PISO TIJOLINHOS  
50 x 50CM / 4 P/M<sup>2</sup> PIGMENTADO



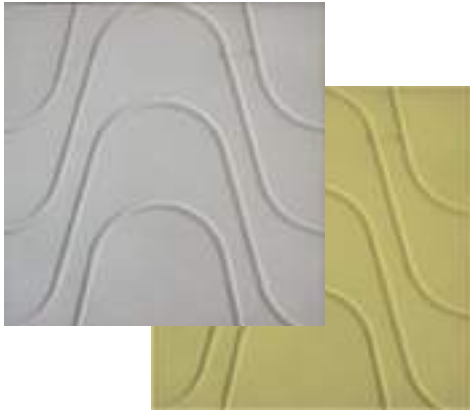

REVESTIMENTO VII

**REV007** REVESTIMENTO PAREDE/PISO COPACABANA  
50 x 50CM / 4 P/M<sup>2</sup>

**REV107** REVESTIMENTO PAREDE/PISO COPACABANA  
50 x 50CM / 4 P/M<sup>2</sup> PIGMENTADO

COD: PDR

PEDRA MADEIRA RÚSTICA

**PDR001** PEDRA MADEIRA RÚSTICA 74 x 30 x 4,5CM

**PDR101** PEDRA MADEIRA RÚSTICA 74 x 30 x 4,5CM  
PIGMENTADO

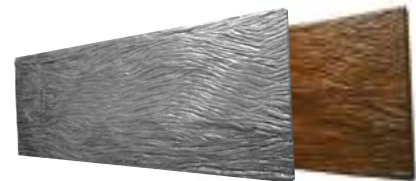

COD: PEZ



PEZÃO PARA JARDIM

**PEZ001** PEDRA PEZÃO SL 55 X 30CM

**PEZ101** PEDRA PEZÃO SL 55 X 30CM PIGMENTADO





## PEDRA LISA

**PDL001** PEDRA LISA SOB MEDIDA M<sup>2</sup>

**PDL101** PEDRA LISA SOB MEDIDA M<sup>2</sup> PIGMENTADO

## PEDRA DRENANTE

**PDD001** PEDRA DRENANTE 45 x 45 X 5CM



## PISO ANTIDERRAPANTE

**PIS001** PISO ANTIDERRAPANTE 50 x 25 x 5 CM | 8 P/M<sup>2</sup>



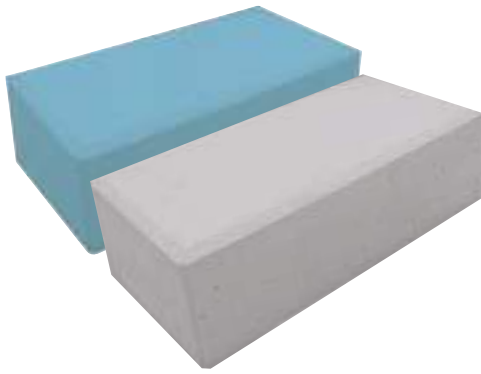

**PISO INTERTRAVADO TIJOLINHO**

- INT001** PISO TIJOLINHO H4 20 x 10CM - 50 P/M<sup>2</sup>
- INT002** PISO TIJOLINHO H4 20 x 10CM - 50 P/M<sup>2</sup> PIGMENTADO
- INT003** PISO TIJOLINHO H6 20 x 10CM - 50 P/M<sup>2</sup>
- INT101** PISO TIJOLINHO H6 20 x 10CM - 50 P/M<sup>2</sup> PIGMENTADO
- INT102** PISO TIJOLINHO H8 20 x 10CM - 50 P/M<sup>2</sup>
- INT103** PISO TIJOLINHO H8 20 x 10CM - 50 P/M<sup>2</sup> PIGMENTADO

**PISO INTERTRAVADO ANTIDERRAPANTE**

- INT004** PISO TIJOLINHO ANTIDERRAPANTE H6 20 x 10CM - 50 P/M<sup>2</sup>
- INT104** PISO TIJOLINHO TIDERRAPANTE H6 20 x 10CM - 50 P/M<sup>2</sup> PIGMENTADO

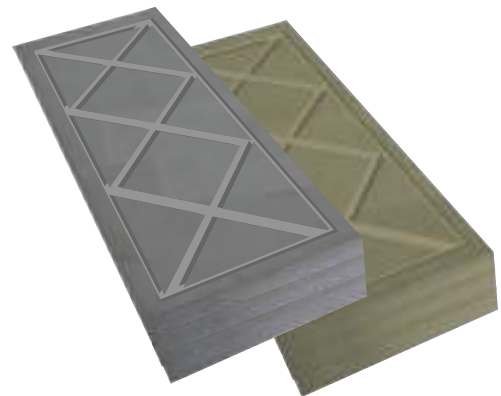

**PISO INTERTRAVADO UNISTAY**

- INT005** PISO UNISTAY (16 FACES) H4 - 42 P/M<sup>2</sup>
- INT006** PISO UNISTAY (16 FACES) H4 - 42 P/M<sup>2</sup> PIGMENTADO
- INT007** PISO UNISTAY (16 FACES) H6 - 42 P/M<sup>2</sup>
- INT105** PISO UNISTAY (16 FACES) H6 - 42 P/M<sup>2</sup> PIGMENTADO
- INT106** PISO UNISTAY (16 FACES) H8 - 42 P/M<sup>2</sup>
- INT107** PISO UNISTAY (16 FACES) H8 - 42 P/M<sup>2</sup> PIGMENTADO





**PISO INTERTRAVADO OSSINHO**

- INT008** PISO OSSINHO H4 - 37 P/M<sup>2</sup>
- INT009** PISO OSSINHO H4 - 37 P/M<sup>2</sup> PIGMENTADO
- INT010** PISO OSSINHO H6 - 37 P/M<sup>2</sup>
- INT108** PISO OSSINHO H6 - 37 P/M<sup>2</sup> PIGMENTADO
- INT109** PISO OSSINHO H8 - 37 P/M<sup>2</sup>
- INT110** PISO OSSINHO H8 - 37 P/M<sup>2</sup> PIGMENTADO

COD: TAT

**PISO PODOTÁTIL**

- TAT001** PISO PODOTÁTIL DIRECIONAL 25 x 25CM - 16 P/M<sup>2</sup>
- TAT002** PISO PODOTÁTIL ALERTA 25 x 25CM - 16 P/M<sup>2</sup>
- TAT101** PISO PODOTÁTIL DIRECIONAL 25 x 25CM - 16 P/M<sup>2</sup> PIGMENTADO
- TAT102** PISO PODOTÁTIL ALERTA 25 x 25CM - 16 P/M<sup>2</sup> PIGMENTADO



COD: TAT



**PISO ANTIDERRAPANTE 21 FRISOS**

- TAT003** PISO 21 FRISOS 30 X 30 CM | 11 P/M<sup>2</sup>
- TAT103** PISO 21 FRISOS 30 X 30 CM | 11 P/M<sup>2</sup> - PIGMENTADO





PISO GRAMA 6 FUROS

GRA001

PISO GRAMA H = 7CM 6 FUROS 43 x 33CM - 7 P/M<sup>2</sup>

PISO GRAMA "S"

GRA002

PISO GRAMA H = 8CM 2 FUROS  
29 x 14,5CM - 23 P/M<sup>2</sup>

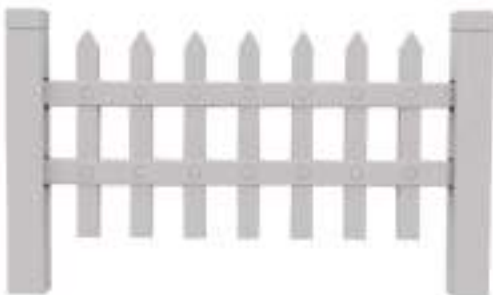

CONJUNTO GRADE CERCA

CGC001

CONJUNTO GRADE CERCA 125 x 60 CM







**TAMPA COM MOLDURA REDONDA**

**TMR001** TAMPA COM MOLDURA REDONDA D = 39,5 CM

**TAMPA COM MOLDURA QUADRADA**

**TMQ001** TAMPA COM MOLDURA QUADRADA 75 x 75 CM



**MEIA CANA EM CONCRETO**

**MCC001** MEIA CANA EM CONCRETO D=30CM | H=1,00M





**RALO EM CONCRETO**

**RCA001** RALO 5 FUROS EM CONCRETO 45 x 30 x 6 CM

**RALO EM CONCRETO**

**RCA002** RALO 12 FUROS EM CONCRETO 50 x 30 x 8 CM



**RALO EM CONCRETO**

**RCA003** RALO 14 FUROS EM CONCRETO 75 x 45 x 7 CM





**CRUZETA PARA POSTE**

- |  |                                      |
|--|--------------------------------------|
| <b>CZT001</b> TIPO T NORMAL 900MM            | <b>CZT005</b> TIPO L BECO 600MM      |
| <b>CZT002</b> TIPO T NORMAL 1900MM           | <b>CZT006</b> TIPO L BECO 1700MM     |
| <b>CZT003</b> TIPO T NORMAL 2400MM           | <b>CZT007</b> TIPO RETANGULAR 2350MM |
| <b>CZT004</b> TIPO T MEIO BECO NORMAL 1900MM |                                      |

**COD: PJA**

**POSTE JARDIM**

- |                      |                         |
|----------------------|-------------------------|
| <b>PJA001</b> H = 5M | <b>PJA005</b> H = 9M    |
| <b>PJA002</b> H = 6M | <b>PJA006</b> H = 10M   |
| <b>PJA003</b> H = 7M | <b>PJA007</b> H = 10,5M |
| <b>PJA004</b> H = 8M |                         |



**COD: PPB**



**POSTE PADRÃO ENEL TIPO B**

- |                             |                              |                               |                               |
|-----------------------------|------------------------------|-------------------------------|-------------------------------|
| <b>PPB001</b> H=5,5M/300DAN | <b>PPB008</b> H=10,0M/150DAN | <b>PPB015</b> H=10,5M/1000DAN | <b>PPB022</b> H=12,0M/600DAN  |
| <b>PPB002</b> H=8M/300DAN   | <b>PPB009</b> H=10,0M/300DAN | <b>PPB016</b> H=11,0M/200DAN  | <b>PPB023</b> H=12,0M/1000DAN |
| <b>PPB003</b> H=8M/600DAN   | <b>PPB010</b> H=10,0M/500DAN | <b>PPB017</b> H=11,0M/300DAN  | <b>PPB024</b> H=13,5M/300DAN  |
| <b>PPB004</b> H=9M/150DAN   | <b>PPB011</b> H=10,0M/600DAN | <b>PPB018</b> H=11,0M/400DAN  | <b>PPB025</b> H=14,0M/300DAN  |
| <b>PPB005</b> H=9M/200DAN   | <b>PPB012</b> H=10,5M/150DAN | <b>PPB019</b> H=11,0M/600DAN  | <b>PPB026</b> H=14,0M/600DAN  |
| <b>PPB006</b> H=9M/300DAN   | <b>PPB013</b> H=10,5M/300DAN | <b>PPB020</b> H=11,0M/1000DAN | <b>PPB027</b> H=15,0M/300DAN  |
| <b>PPB007</b> H=9M/600DAN   | <b>PPB014</b> H=10,5M/600DAN | <b>PPB021</b> H=12M/300DAN    |                               |





**POSTE PADRÃO ENEL TIPO D**

<b>PPD001</b>	H=4M/100DAN	<b>PPD006</b>	H=8M/150DAN	<b>PPD011</b>	H=9M/600DAN
<b>PPD002</b>	H=5M/100DAN	<b>PPD007</b>	H=8M/200DAN	<b>PPD012</b>	H=10M/150DAN
<b>PPD003</b>	H=6M/100DAN	<b>PPD008</b>	H=9M/150DAN	<b>PPD013</b>	H=10,5M/300DAN
<b>PPD004</b>	H=7M/100DAN	<b>PPD009</b>	H=9M/200DAN	<b>PPD014</b>	H=11M/200DAN
<b>PPD005</b>	H=7M/150DAN	<b>PPD010</b>	H=9M/300DAN		

**COD: PCI**

**POSTE CIRCULAR**

<b>PCI001</b>	H=8M/200DAN	<b>PCI001</b>	H=12M/200DAN
<b>PCI002</b>	H=9M/200DAN	<b>PCI002</b>	H=14M/200DAN
<b>PCI003</b>	H=10M/200DAN	<b>PCI003</b>	H=15M/200DAN
<b>PCI004</b>	H=11M/200DAN	<b>PCI004</b>	H=16M/200DAN



**COD: CHU**



**CHURRASQUEIRA MODELO TIJOLINHO**

<b>CHU001</b>	CHURRASQUEIRA PRÉ-MOLDADO NATURAL L = 65CM / P = 55CM / H = 220CM
<b>CHU002</b>	CHURRASQUEIRA PRÉ-MOLDADO COR L = 65CM / P = 55CM / H = 220CM





VIGAS/VERGA E CONTRA VERGA

VIG001	VIGA SIMPLES 1,00M x 0,10M	VIG006	VIGA SIMPLES 1,50M x 0,10M
VIG002	VIGA SIMPLES 1,10M x 0,10M	VIG007	VIGA SIMPLES 1,60M x 0,10M
VIG003	VIGA SIMPLES 1,20M x 0,10M	VIG008	VIGA SIMPLES 1,70M x 0,10M
VIG004	VIGA SIMPLES 1,30M x 0,10M	VIG009	VIGA SIMPLES 1,80M x 0,10M
VIG005	VIGA SIMPLES 1,40M x 0,10M	VIG010	VIGA SIMPLES 2,00M x 0,10M

VIGAS

VIG011	VIGA 4 FERROS 10MM / 2,00 x 0,10M	VIG016	VIGA 4 FERROS 10MM / 3,00 x 0,10M
VIG012	VIGA 4 FERROS 10MM / 2,20 x 0,10M	VIG017	VIGA 6 FERROS 10MM / 2,50 x 0,10M
VIG013	VIGA 4 FERROS 10MM / 2,30 x 0,10M	VIG018	VIGA 6 FERROS 10MM / 3,00 x 0,10M
VIG014	VIGA 4 FERROS 10MM / 2,40 x 0,10M	VIG019	VIGA 6 FERROS 10MM / 4,00 x 0,10M
VIG015	VIGA 4 FERROS 10MM / 2,50 x 0,10M		

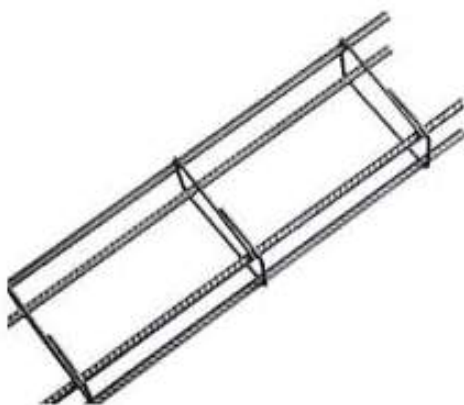

FERRAGENS E ARMAÇÕES EM GERAL

FEG001	ARMAÇÃO COM 4 FERROS 10MM (7x17 CM)
FEG002	ARMAÇÃO COM 4 FERROS 8MM (7x14 CM)
FEG003	ARMAÇÃO SOB ENCOMENDA

L = LARGURA / P = PROFUNDIDADE / H = ALTURA





JARRO CONE

- JAR001 JARRO CONE EM CONCRETO - PEQUENO
- JAR002 JARRO CONE EM CONCRETO - MÉDIO
- JAR003 JARRO CONE EM CONCRETO - GRANDE

JARRO COMUM

- JAR004 JARRO COMUM 25 x 25CM
- JAR005 JARRO COMUM 30 x 30CM
- JAR006 JARRO COMUM 40 x 40CM
- JAR007 JARRO COMUM 60 x 60CM
- JAR008 JARRO COMUM 70 x 70CM



JARRO JARDINEIRA

- JAR009 JARRO JARDINEIRA / 62 x 27CM
- JAR010 JARRO JARDINEIRA / 82 x 27CM
- JAR011 JARRO JARDINEIRA / 100 x 27CM
- JAR012 JARRO JARDINEIRA / 100 x 32CM





**COMPORTA DE DRENAGEM SIMPLES**

**CDS001**

COMPORTA DE DRENAGEM SIMPLES  
(2 CABEÇAS | 4 MANILHAS EM "U" | 2 "L")

COD: CDY

**COMPORTA DE DRENAGEM "Y"**

**CDY001**

COMPORTA DE DRENAGEM EM "Y" COMPLETA  
(03 CABEÇAS | 12 MANILHAS EM "U" | 02 "L")



COD: CAB

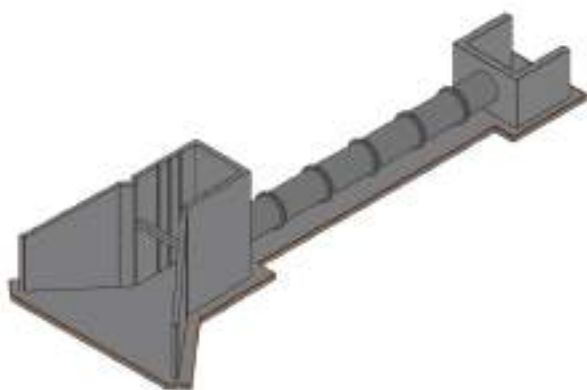

**COMPORTAMENTO DE ABASTECIMENTO**

**CAB001**

COMPORTA DE ABASTECIMENTO COMPLETA  
(01 CABEÇA | 06 MANILHAS DE 40 CM)



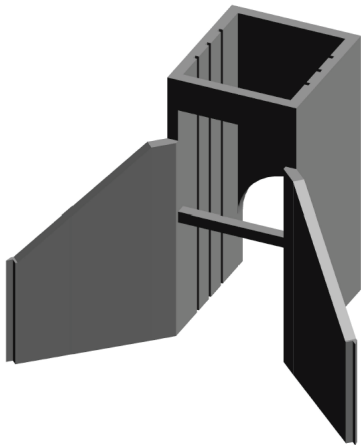

**CABEÇA COMPORTA DE DRENAGEM**

**CCD001** CABEÇA COMPORTA DE DRENAGEM - 2,50M

**CABEÇA COMPORTA DE ABASTECIMENTO**

**CCA001** CABEÇA COMPORTA DE ABASTECIMENTO - 2,00M

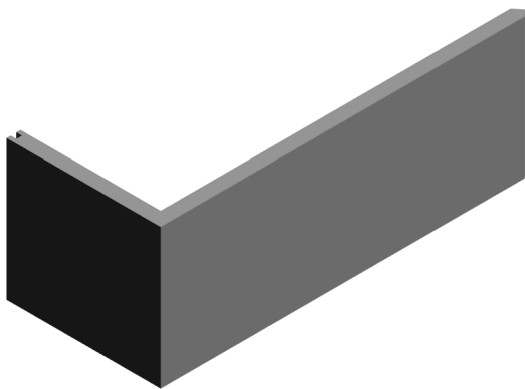

**"L" EM CONCRETO**

**LPC001** "L" PARA COMPORTA EM CONCRETO  
110 X 265 X 100 CM







**MANILHA ESPECIAL "U"**

**MAU001** MANILHA EM "U" D = 100CM / H = 100CM M/F

**COD: LCR**

**LOCAÇÃO DE RETROSCAVADEIRA**

**LCR001** SERVIÇO DE LOCAÇÃO DE RETROSCAVADEIRA



**COD: LCM**

**LOCAÇÃO DE CAMINHÃO MUNCK**

**LCM001** SERVIÇO DE LOCAÇÃO DE CAMINHÃO MUNCK





**LOCAÇÃO DE CAMINHÃO BASCULANTE**

**LCB001**

SERVIÇO DE LOCAÇÃO DE CAMINHÃO BASCULANTE (CAÇAMBA)

**LOCAÇÃO DE BETONEIRA**

**LBE001**

SERVIÇO DE LOCAÇÃO DE BETONEIRA ELÉTRICA



**LOCAÇÃO DE EQUIPAMENTOS ELÉTRICOS**

**LEE001**

SERVIÇO DE LOCAÇÃO DE ROMPEDOR ELÉTRICO

**LEE002**

SERVIÇO DE LOCAÇÃO DE VIBRADOR ELÉTRICO



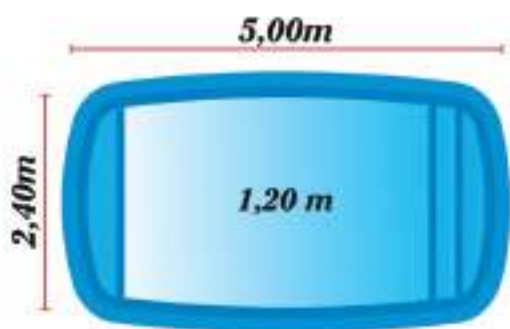

### PISCINA RIO PACOTI

**PSC001** PISCINA L = 2,40 / C = 5,00 / P = 1,20 M

**COD: PSC**

### PISCINA RIO SÃO FRANCISCO

**PSC002** PISCINA L = 3,40 / C = 10,00 / P = 1,40 M

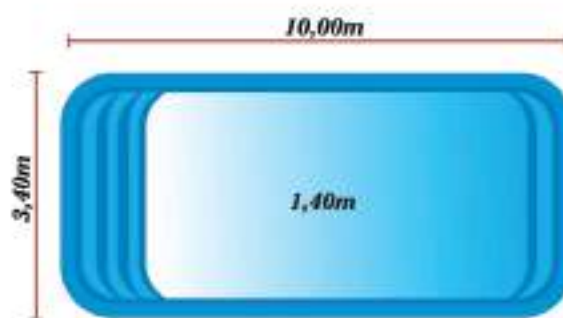

**COD: PSC**

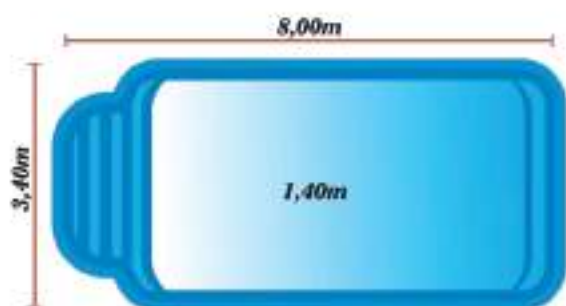

### PISCINA RIO JAGUARIBE

**PSC003** PISCINA L = 3,40 / C = 8,00 / P = 1,40 M



PISCINA RIO MADEIRA

PSC004 PISCINA L = 3,40 / C = 7,00 / P = 1,40 M

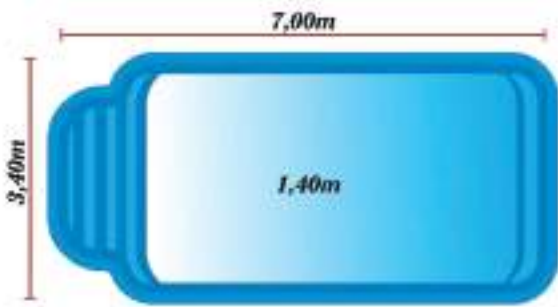

COD: PSC

PISCINA RIO DOCE

PSC005 PISCINA L = 3,40 / C = 6,00 / P = 1,40 M

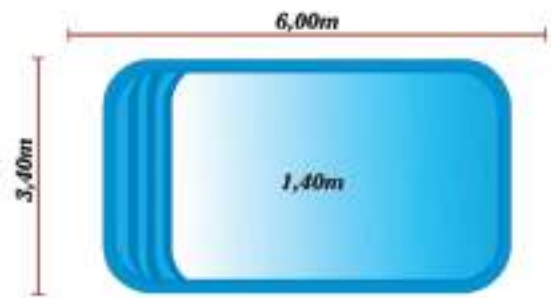

COD: PSC

PISCINA RIO POTENGI

PSC006 PISCINA L = 2,75 / C = 5,00 / P = 1,20 M

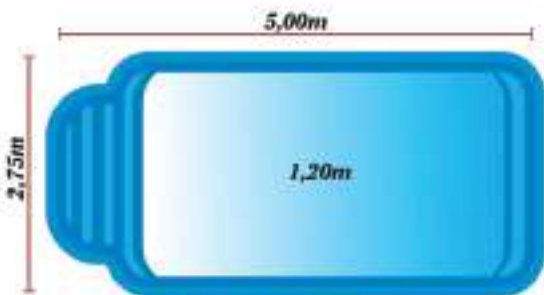

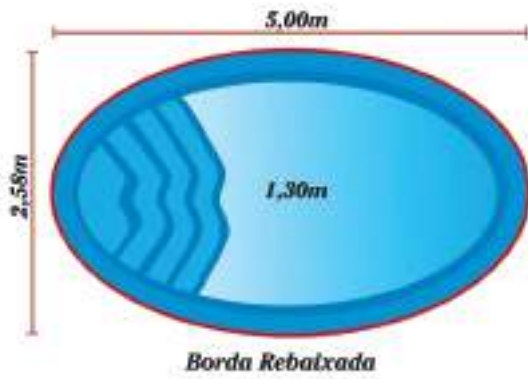

**PISCINA RIO PIRANHAS (BORDA REBAIXADA)**

**PSC007** PISCINA L = 2,58 / C = 5,00 / P = 1,30 M

**PISCINA RIO APODI**

**PSC008** PISCINA L = 2,40 / C = 4,90 / P = 1,38 M

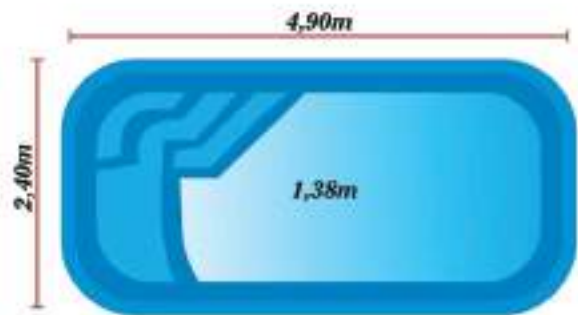

**PISCINA LAGO DO AMOR**

**PSC009** PISCINA L = 2,50 / C = 4,00 / P = 1,30 M

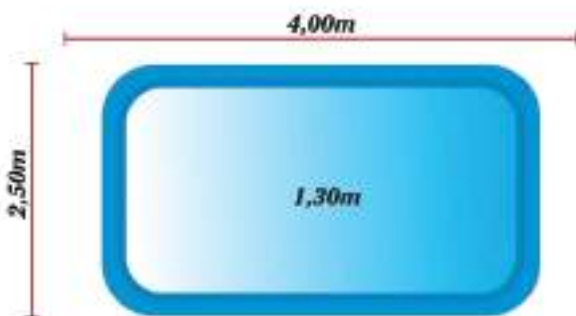

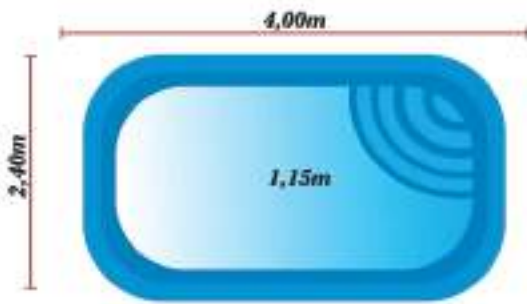

PISCINA LAGOA DO PIATO

PSC010 PISCINA L = 2,40 / C = 4,00 / P = 1,15 M

PISCINA LAGOA DOS PATOS

PSC011 PISCINA L = 2,50 / C = 4,00 / P = 0,65 M

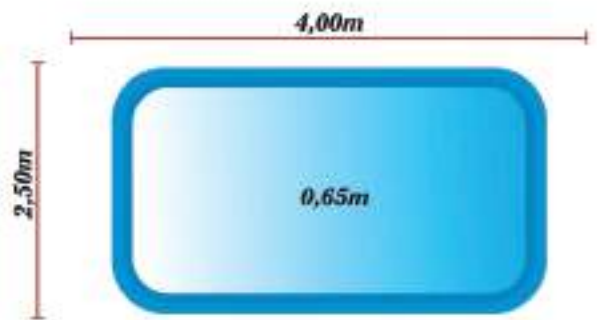

PISCINA LAGOA DO PEIXE (BORDA REBAIXADA)

PSC012 PISCINA L = 2,20 / C = 4,00 / P = 1,30 M

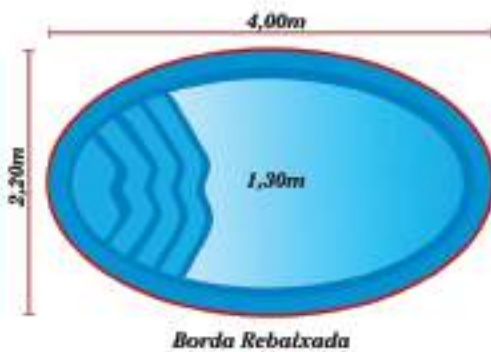

PISCINA LAGO CISNE

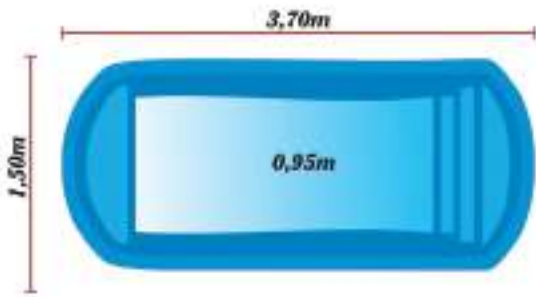

PSC013 PISCINA L = 1,50 / C = 3,70 / P = 0,95 M

COD: PSC

PISCINA LAGO DO SORRISO

PSC014 PISCINA L = 1,45 / C = 2,45 / P = 0,70 M

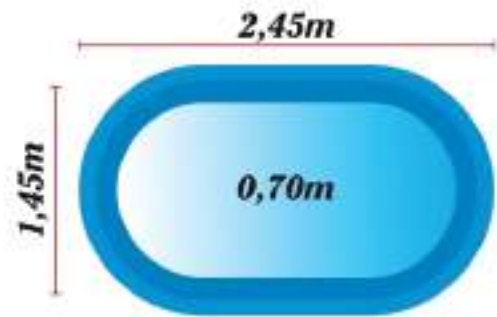

*L = LARGURA / C = COMPRIMENTO / P = PROFUNDIDADE*

EDN PRÉ-FABRICADOS





## EDN PRÉ-FABRICADOS



### ONDE NOS ENCONTRAR

ROD. CE - 265, 463 - PLANALTO AEROPORTO | MORADA NOVA - CE | 62940-000

☎ 88 2135 0263 | 88 99989 0470 ☎

✉ ednprefabricados@gmail.com 📷 @ednprefabricados

📘 fb.me/ednprefabricados 🌐 www.ednprefabricados.com.br